

# DMX512 DECODER

LT-916-OLED

16  
CHANNELS

- OLED display
- 8 bit / 16 bit
- 3 kinds of DMX interfaces
- Dimming Curve: 0.1-9.9
- Short circuit / Over current protection



www.ltech-led.com

## Product Introduction:

1. Designed for Hi-power multiple channels application, 16 channels output, and Max. 3A current per channel, up to 1152W output power.
2. Easy operation with OLED screen and touch buttons.
3. 4 kinds of mode optional: single color, color temperature, RGB, RGBW.
4. Support 3 kinds of DMX ports with signal isolation function: 5-pin XLR, RJ45 and green terminal (with signal amplifier function).
5. With RDM remote management protocol, the operations can be completed via the RDM master console, such as parameters browsing & setting, DMX address setting, equipment recognition, etc.
6. With photoelectric isolation function.
7. With short circuit protection and over current protection, as well as warning function when fault.
8. With fast self-testing function.
9. 16bit (65536 levels) / 8bit (256 levels) grey level optional.
10. Multiple dimming curve (0.1-9.9) optional.

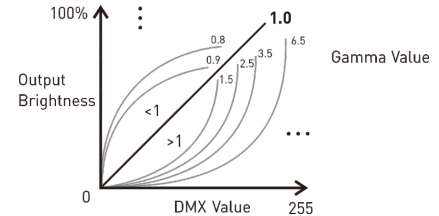

5-pin XLR



RJ45



RDM



Photoelectric Isolation



Short Circuit Protection



Over Current Protection



Display

## Technical Specs:

Model :	LT-916-OLED
Input Signal :	DMX512/RDM
Input Voltage :	12~24Vdc
Current Load :	3A × 16CH Max 48A
Output Power :	[0~36W...72W] × 16CH Max. 1152W
DMX Interface :	5-pin XLR, RJ45, Green terminal
Control Mode :	Dimming/CT/RGB/RGBW
Dimming Curve :	0.1~9.9
Grey Level :	8bit (256 levels) / 16bit (65536 levels)
Photoelectric Isolation :	Yes
Protection:	Short circuit / Over current
Working Temperature :	-30°C~65°C
Dimensions :	L180×W122×H39mm
Package Size :	L193×W127×H41mm
Weight (G.W.) :	730g



## Product Size:

Unit: mm

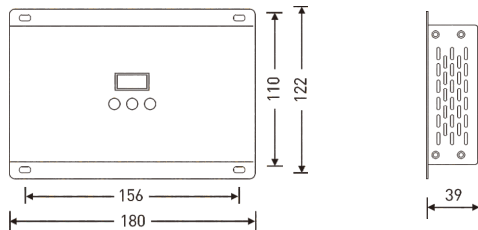

## Main Component Description:

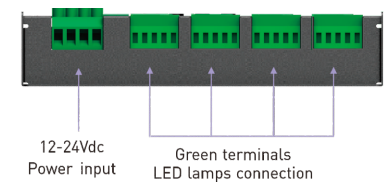
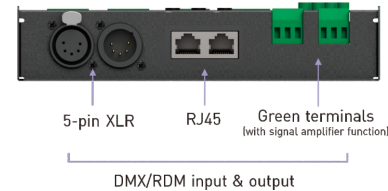
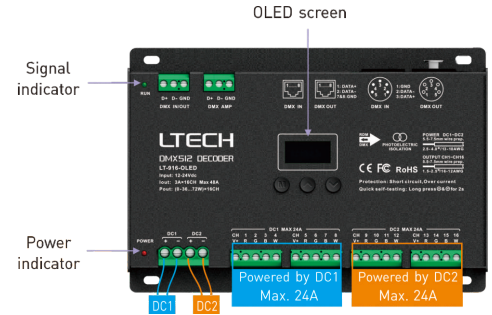

## OLED Screen Interface:



Press "M" key, switch entries.  
 Long press "M" key, back to previous page.  
 Press "^" or "v" key, parameter adjustment.  
 Exit: back to previous page.

### 1. DMX Address Setting

DMX: **001** Hz: High  
 Mode: RGBW 8bit  
 Curve: Standard  
 Dim: Smo TOOL&v

Press "^" or "v" key to set DMX address.  
 Range: 001-512

Main page

### 2. PWM Frequency

DMX: 001 Hz: **High**  
 Mode: RGBW 8bit  
 Curve: Standard  
 Dim: Smo TOOL&v

Press "^" or "v" key to choose.

Optional : **Std (standard)**  
 High  
 Mid (middle)  
 Low

Smooth and delicate,  
 human eye  
 is comfortable.

\* It is recommended to  
 use standard.

No flicker in  
 video camera.

### 3. Mode

DMX: 001 Hz: High  
 Mode: **RGBW** 8bit  
 Curve: Standard  
 Dim: Smo TOOL&v

Press "^" or "v" key to choose.

Optional : Dim  
 CT  
 RGB  
 RGBW

### 4. Grey Level

DMX: 001 Hz: High  
 Mode: RGBW **8bit**  
 Curve: Standard  
 Dim: Smo TOOL&v

Press "^" or "v" key to choose.

Optional : 8bit  
 16bit (choose it if master controller  
 support this function)

### 5. Dimming Curve

DMX: 001 Hz: High  
 Mode: RGBW 8bit  
 Curve: **Standard**  
 Dim: Smo TOOL&v

Press "^" or "v" key to choose.

Optional : **Standard**  
 Linear  
 0.1-9.9

It is recommended to use standard,  
 0.1-9.9 is for special requirements.

### 6. Enhance Dimming

DMX: 001 Hz: High  
 Mode: RGBW 8bit  
 Curve: Standard  
**Dim: Smo** TOOL&v

Press "^" or "v" key to choose.

Optional : **Std (standard)**  
 Smo (smooth)

\* It is recommended to use standard.

Smo: This option with smooth processing, realize  
 the dimming flicker-free and dynamic effects  
 more downy.

7. Tool

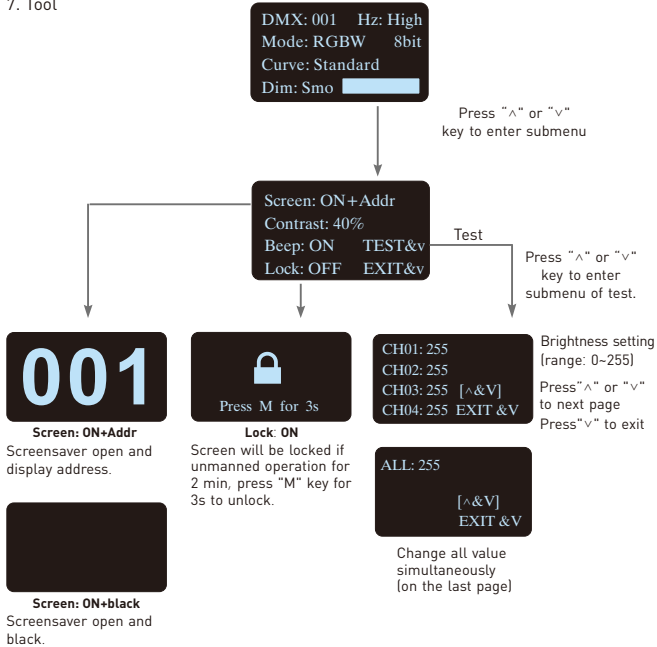

\* Fast self-testing function: press “^” or “v” keys simultaneously for 2-3 seconds under any page, decoder will enter self-testing function.

Wiring Diagram:

1. DMX console connection:

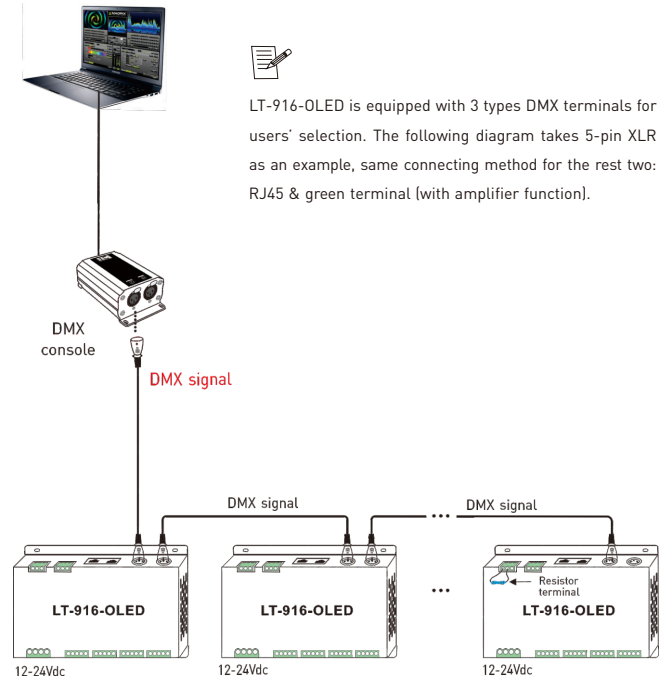

LT-916-OLED is equipped with 3 types DMX terminals for users' selection. The following diagram takes 5-pin XLR as an example, same connecting method for the rest two: RJ45 & green terminal (with amplifier function).

\* If the recoil effect occurs because of longer signal line or bad line quality, please try to connect 0.25W 90-120Ω terminal resistor at the end of each line.

2. Connecting LED lights:

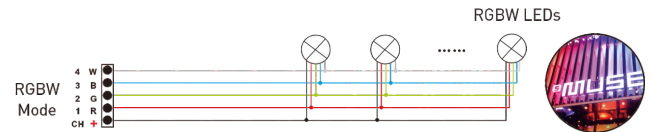
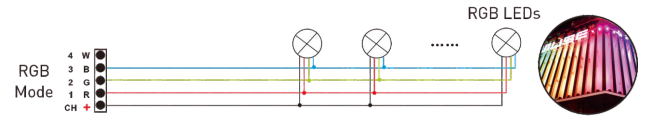
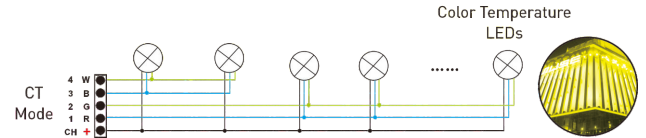
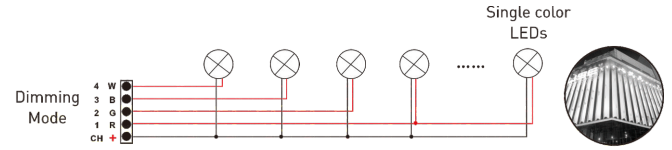
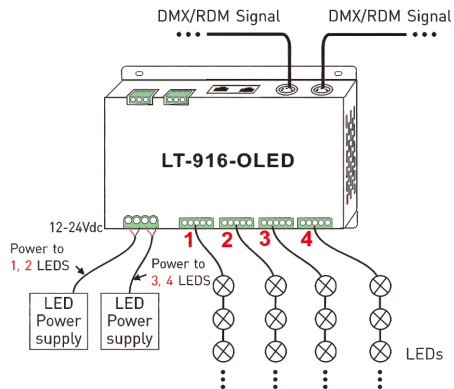
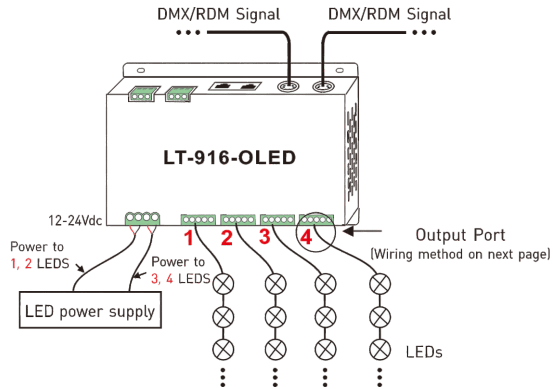

3. The connection diagram of 3 kinds of DMX/RDM terminals:

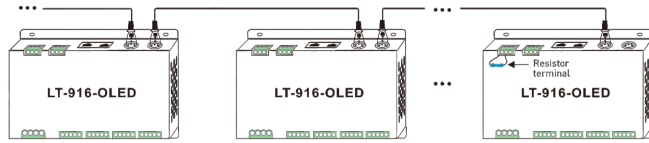

5-pin XLR Connected in Parallel

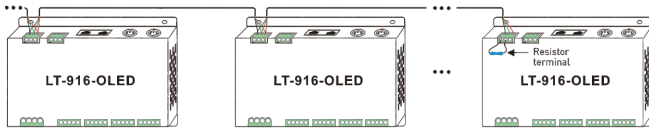

Green Terminal Connected in Parallel

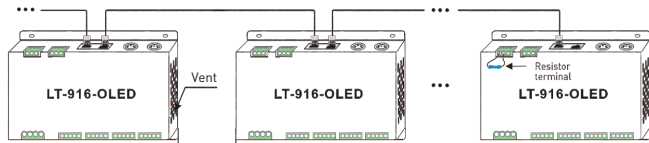

Installation distance > 20mm

RJ45 Connected in Parallel

These 3 terminals can be connected in a mixed way.

\*Installation Attention : please reserve enough ventilation distance between decoders (>20mm), be sure not to block the vent, or will affect lifetime of decoder for poor heat dissipation.

4. The connection diagram of AMP signal amplifier terminal:

\* Connecting with green terminal or an extra amplifier will be needed when more than 32 decoders are connected or use overlong signal wire(as shown below). Signal amplifier should not be more than 5 times continuously.

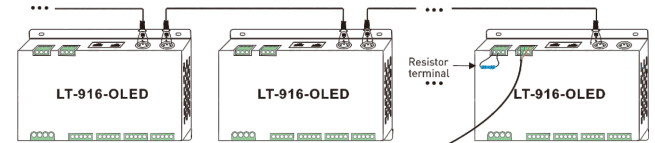

AMP

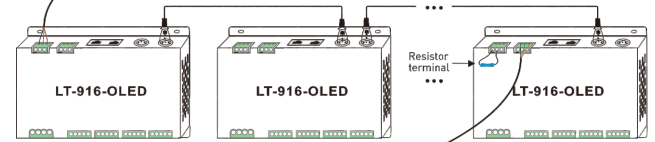

AMP

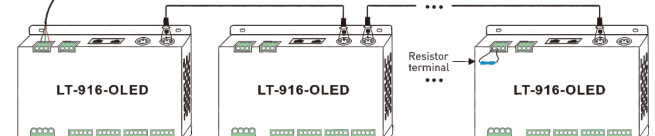

Address setting table

Mode		DIM	CT	RGB	RGBW	Mode		DIM	CT	RGB	RGBW
Address Quantity		4	8	12	16	Address Quantity		8	16	24	32
Resolution		8bit	8bit	8bit	8bit	Resolution		16bit	16bit	16bit	16bit
Channel	1	001	001	001	001	Channel	1	001 002	001 002	001 002	001 002
	2	001	002	002	002		2	001 002	003 004	003 004	003 004
	3	001	001	003	003		3	001 002	001 002	005 006	005 006
	4	001	002	003	004		4	001 002	003 004	005 006	007 008
	5	002	003	004	005		5	003 004	005 006	007 008	009 010
	6	002	004	005	006		6	003 004	007 008	009 010	011 012
	7	002	003	006	007		7	003 004	005 006	011 012	013 014
	8	002	004	006	008		8	003 004	007 008	011 012	015 016
	9	003	005	007	009		9	005 006	009 010	013 014	017 018
	10	003	006	008	010		10	005 006	011 012	015 016	019 020
	11	003	005	009	011		11	005 006	009 010	017 018	021 022
	12	003	006	009	012		12	005 006	011 012	017 018	023 024
	13	004	007	010	013		13	007 008	013 014	019 020	025 026
	14	004	008	011	014		14	007 008	015 016	021 022	027 028
	15	004	007	012	015		15	007 008	013 014	023 024	029 030
	16	004	008	012	016		16	007 008	015 016	023 024	031 032